

1/2" Flooring Profiles

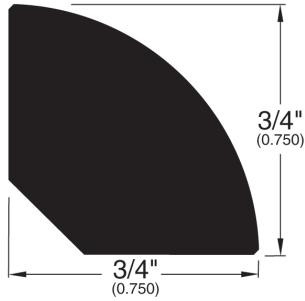

Quarter Round (001)

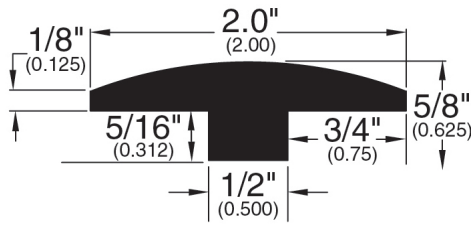

T-Mold (002)

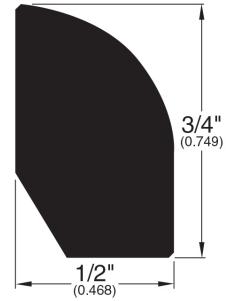

Base Shoe (024)

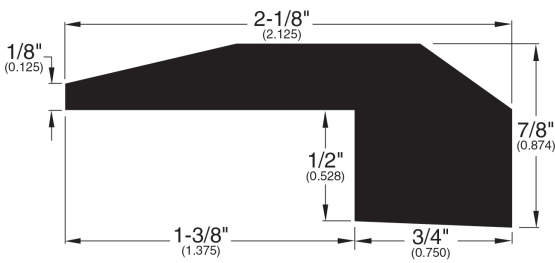

Threshold (011)

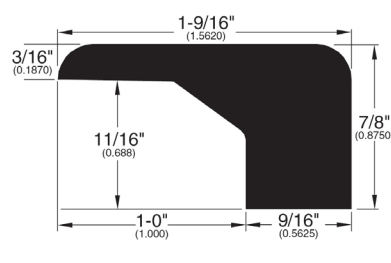

Square Nose (027)

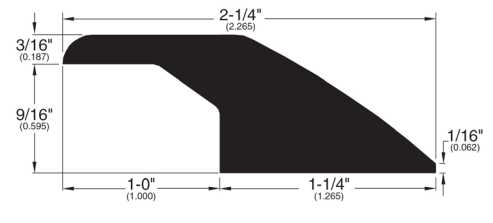

Reducer Overlap (035)

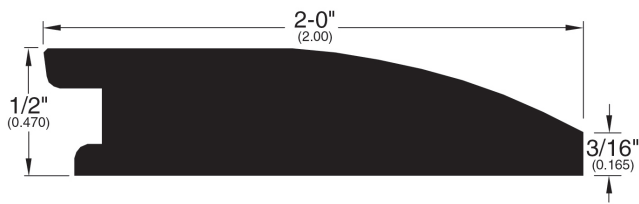

Reducer (010)

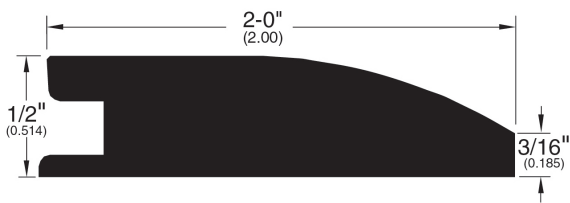

Reducer (090)

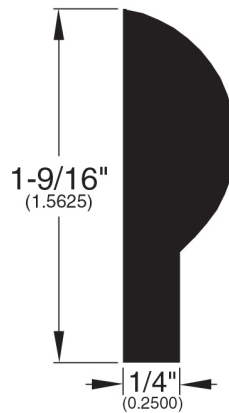

Stair Nose Adjustable (058)

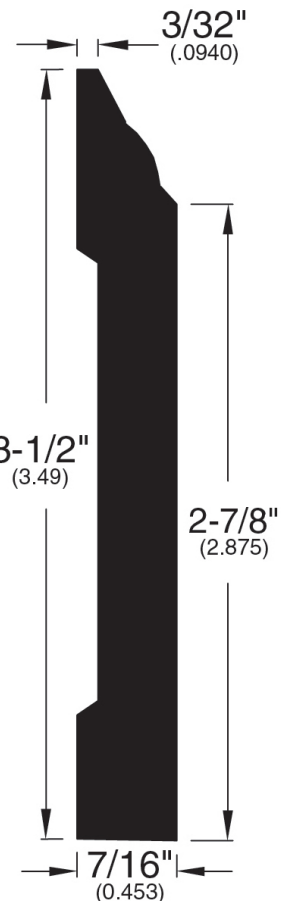

Wall Base (003)

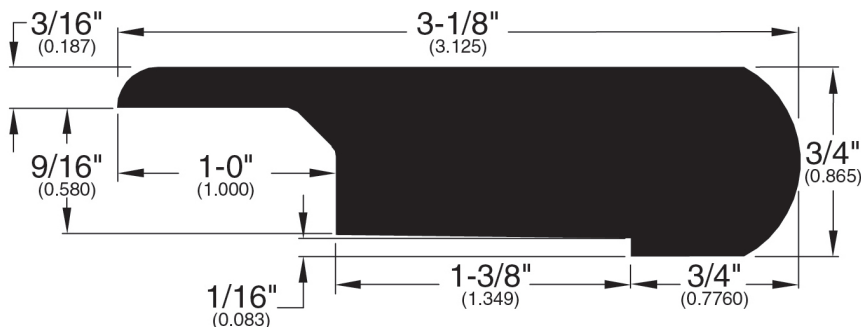

Stair Nose Overlap (036)

1/2" Flooring Profiles

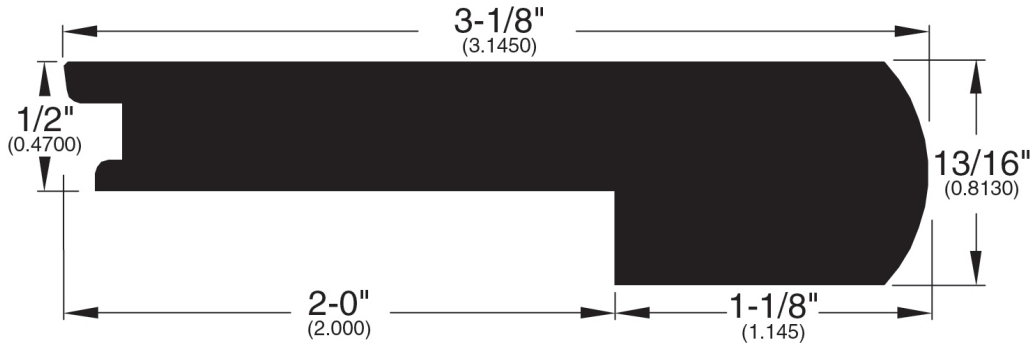

Stair Nose (012)

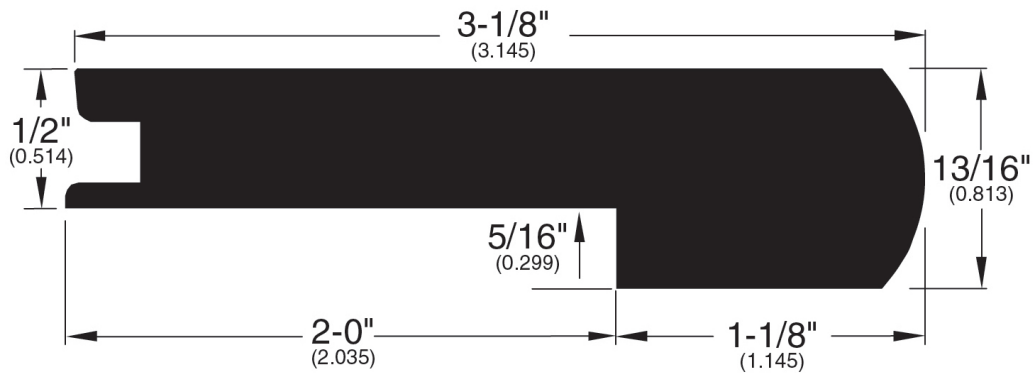

Stair Nose (091)

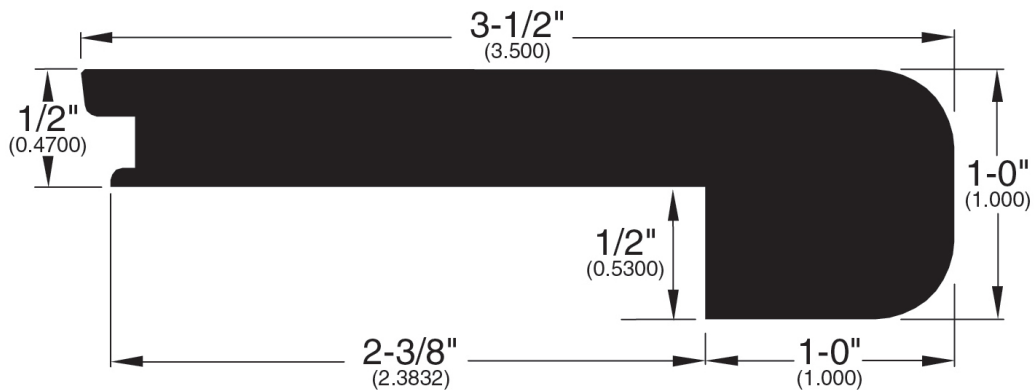

Stair Nose (219)