

## Enduracor™ Flooring Profiles

2.5 MM - 5.5 MM

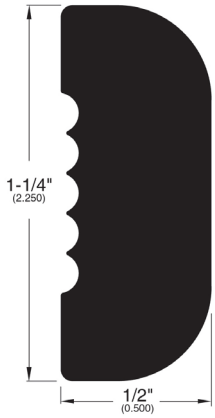

Stair Nose Adjustable (059)

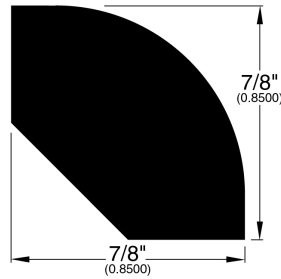

Quarter Round (296)

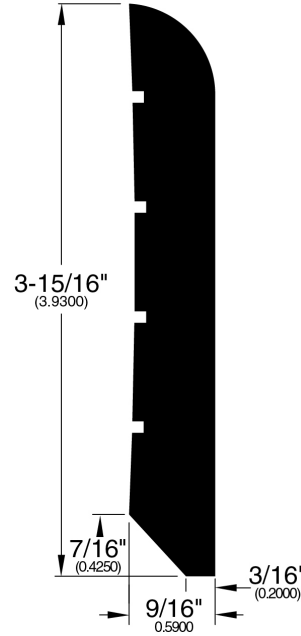

Wall Base (294)

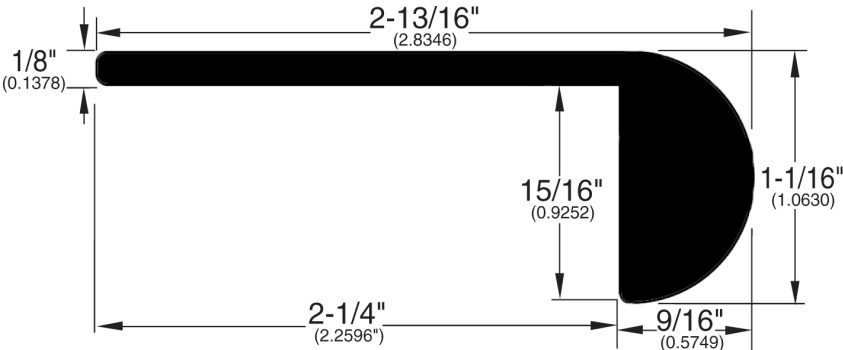

Stair Nose (298)

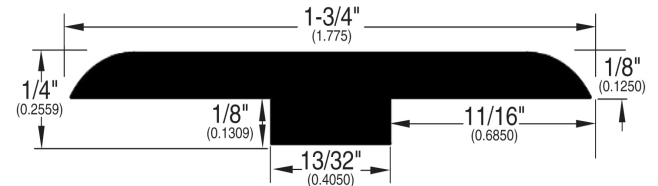

T-Mold (299) \*fits up to 6mm floors

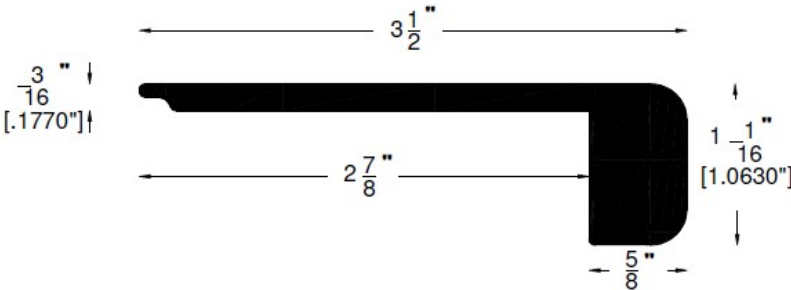

Stair Nose Square Edge (340)

\*fits 4.5 to 6.5mm floors

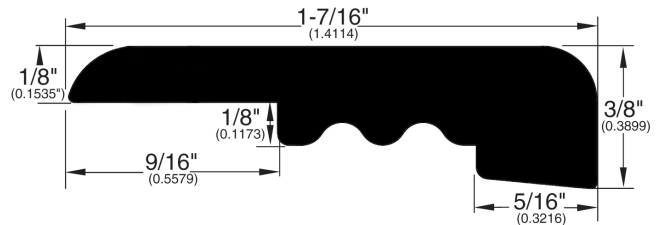

Square Nose (300)

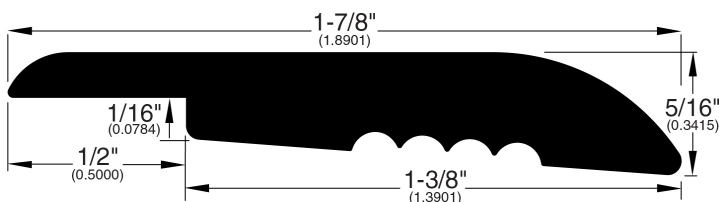

Overlap Reducer (297)

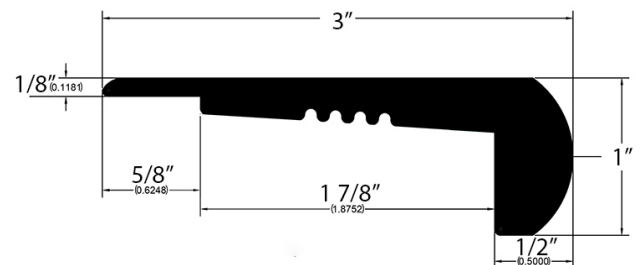

Stair Nose (273) \*fits up to 6mm floors

## Enduracor™ Flooring Profiles

### 6 MM - 10 MM

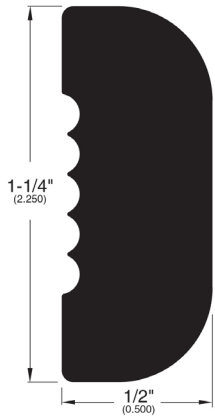

Stair Nose Adjustable (059)

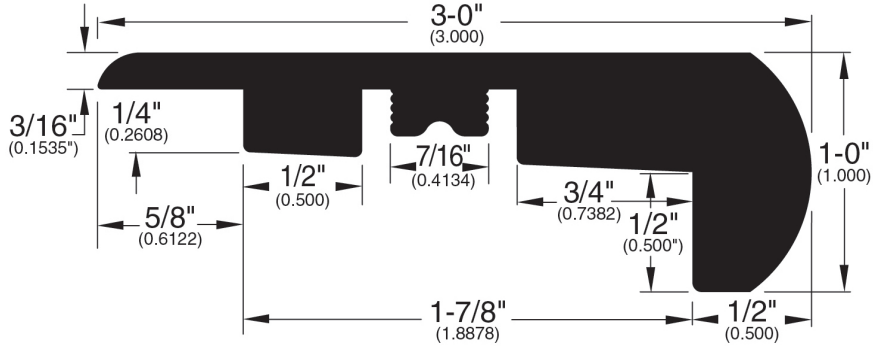

Overlap Stair Nose (283)

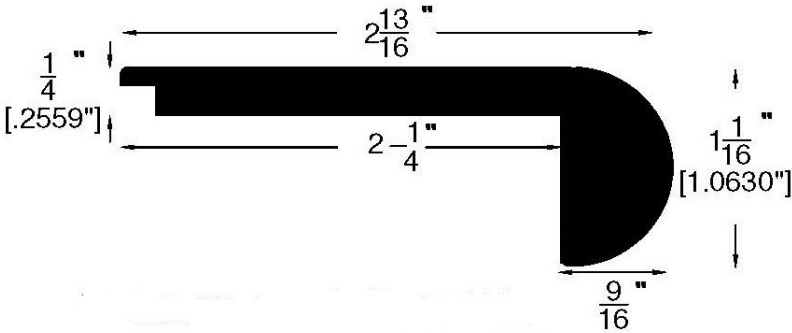

Stair Nose (288)

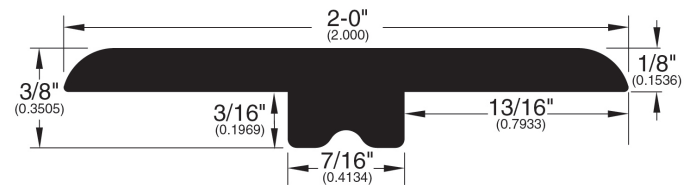

T-Mold (289)

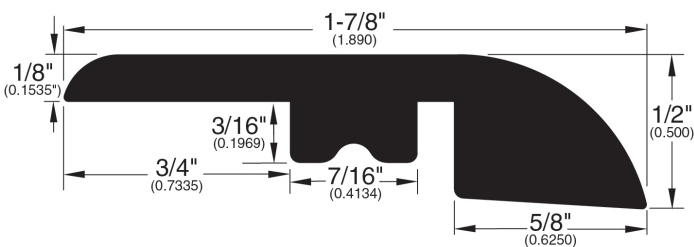

Overlap Reducer (290)

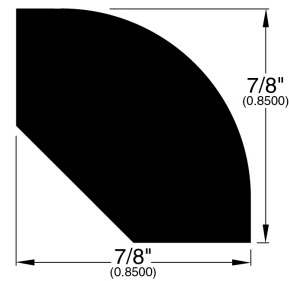

Quarter Round (296)

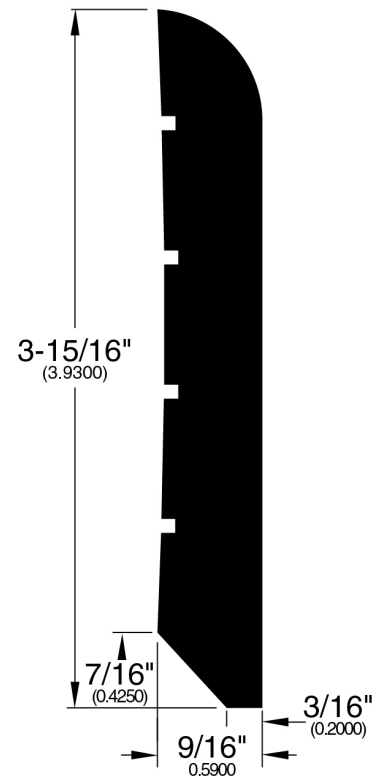

Wall Base (294)

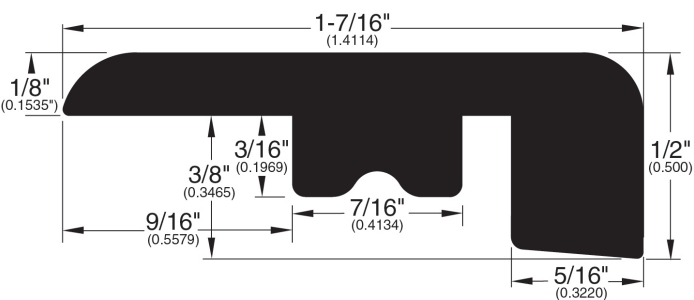

Square Nose (291)

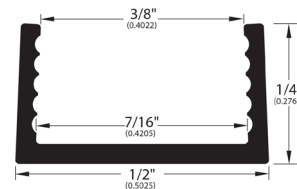

Track (286)

# Enduracor™ Flooring Profiles

## 10 MM - 12 MM

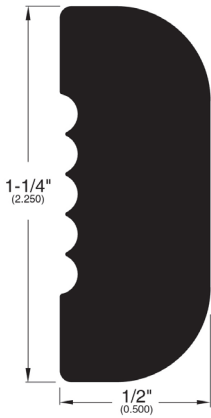

Stair Nose Adjustable (059)

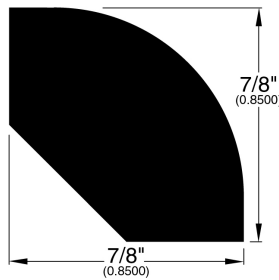

Quarter Round (296)

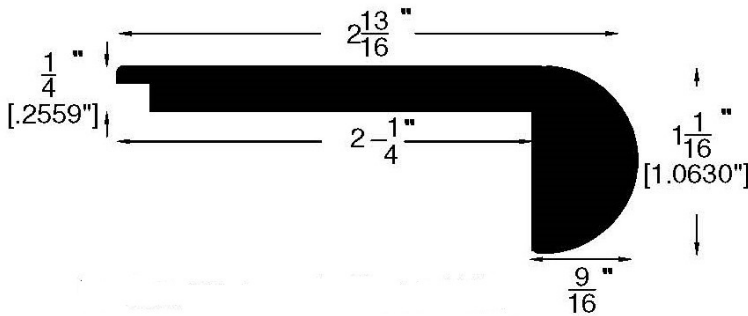

Stair Nose (288)\*

\*Note: a min. of 1/4" adhesive is required for 12 mm floor installs

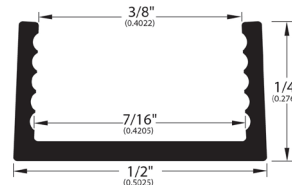

Track (286)

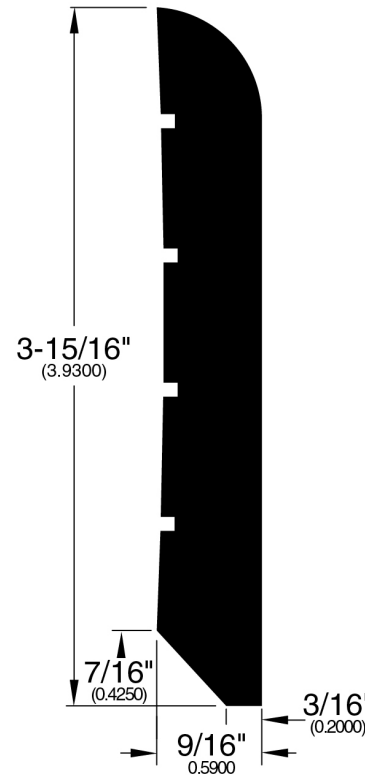

Wall Base (294)

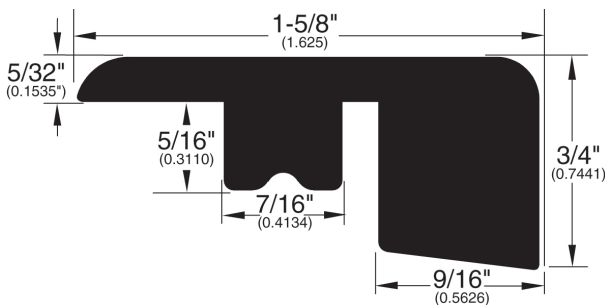

Square Nose (338)

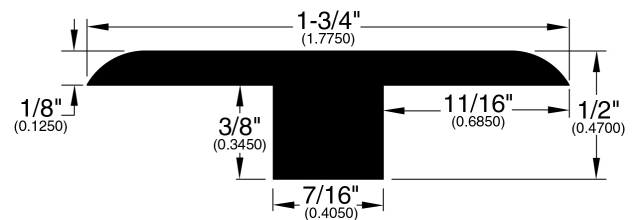

T-Mold (295)

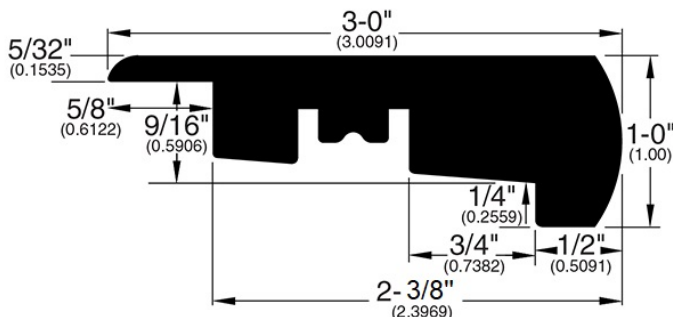

Enduracor Overlap Stair Nose (292)

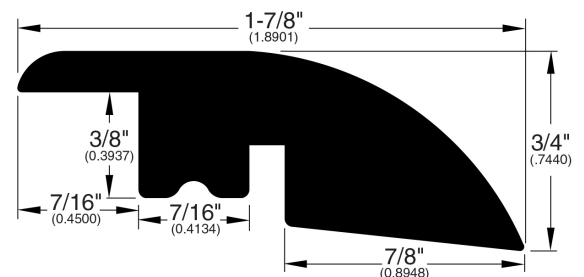

Overlap Reducer (293)

# Enduracor™ Flooring Profiles

## 12 MM - 15 MM

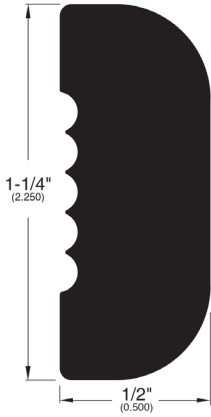

Stair Nose Adjustable (059)

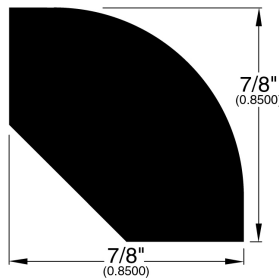

Quarter Round (296)

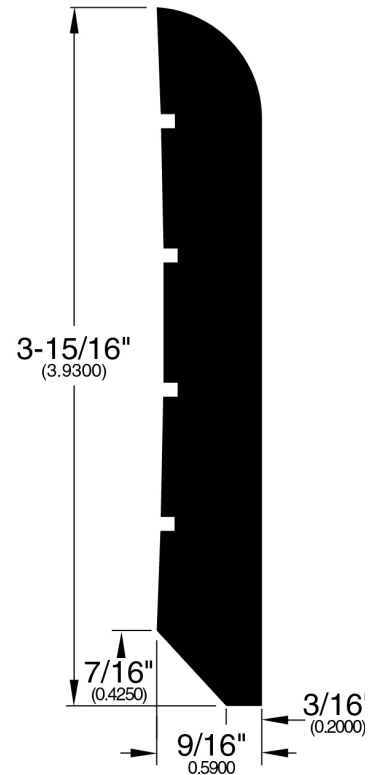

Wall Base (294)

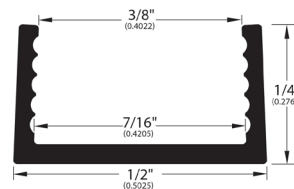

Track (286)

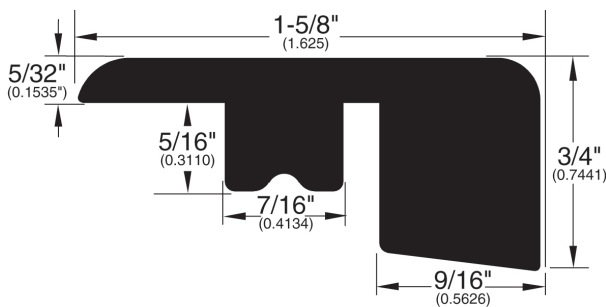

Square Nose (338)

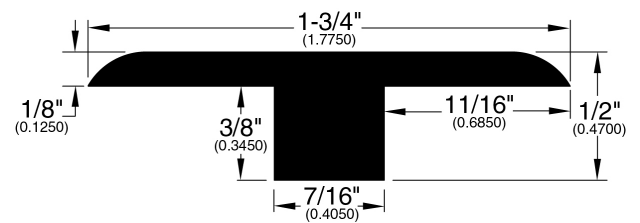

T-Mold (295)

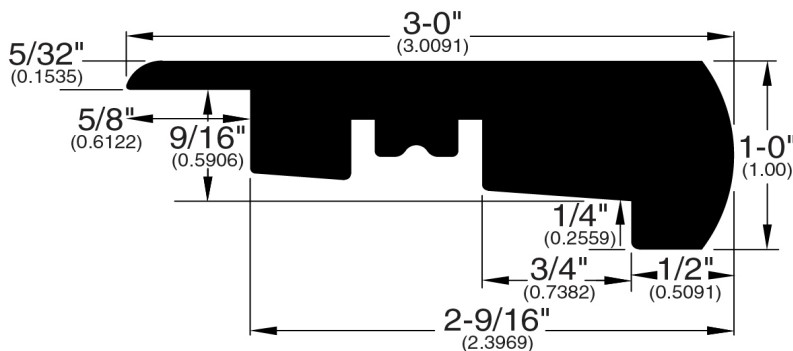

Overlap Stair Nose (292)

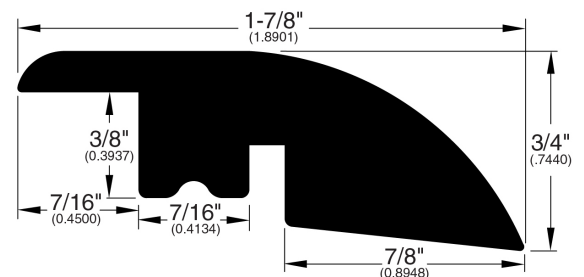

Overlap Reducer (293)